

# International IOR Rectifier

## 1N5820

### SCHOTTKY RECTIFIER

### 3.0 Amp

#### Major Ratings and Characteristics

Characteristics	1N5820	Units
$I_{F(AV)}$ Rectangular waveform	3.0	A
$V_{RRM}$	20	V
$I_{FSM}$ @ $t_p = 5 \mu s$ sine	450	A
$V_F$ @ $3 A_{pk}, T_J = 25^\circ C$	0.475	V
$T_J$	- 65 to 150	$^\circ C$

#### Description/ Features

The 1N5820 axial leaded Schottky rectifier has been optimized for very low forward voltage drop, with moderate leakage. Typical applications are in switching power supplies, converters, free-wheeling diodes, and reverse battery protection.

- Low profile, axial leaded outline
- High purity, high temperature epoxy encapsulation for enhanced mechanical strength and moisture resistance
- Very low forward voltage drop
- High frequency operation
- Guard ring for enhanced ruggedness and long term reliability

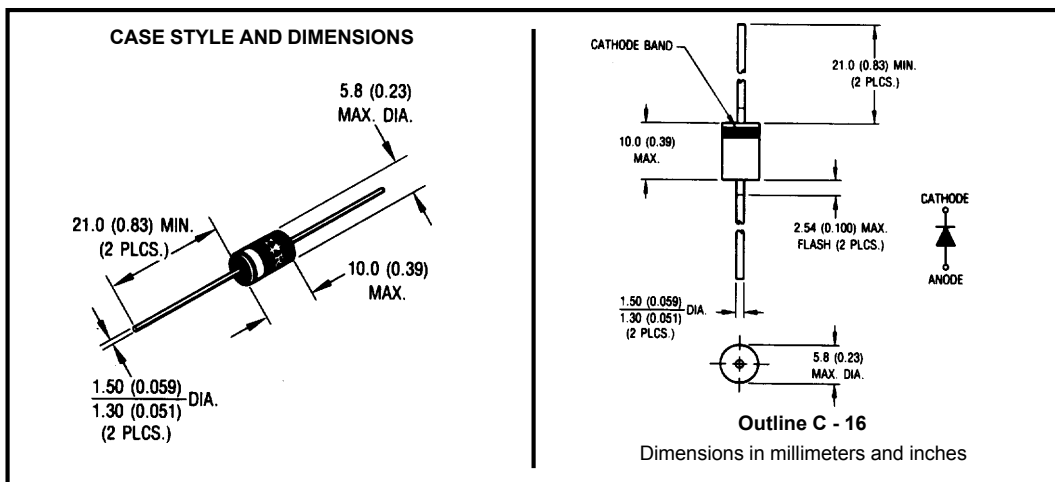

## Voltage Ratings

Part number	1N5820
$V_R$ Max. DC Reverse Voltage (V)	20
$V_{RWM}$ Max. Working Peak Reverse Voltage (V)	

## Absolute Maximum Ratings

Parameters	1N5820	Units	Conditions
$I_{F(AV)}$ Max. Average Forward Current	3.0	A	50% duty cycle @ $T_L = 114^\circ\text{C}$ , rectangular wave form With cooling fins
$I_{FSM}$ Max. Peak One Cycle Non-Repetitive Surge Current, @ $T_J = 25^\circ\text{C}$	450	A	5 $\mu\text{s}$ Sine or 3 $\mu\text{s}$ Rect. pulse
	90		10ms Sine or 6ms Rect. pulse

Following any rated load condition and with rated  $V_{RWM}$  applied

## Electrical Specifications

Parameters	Typ.	Max.	Units	Conditions
$V_{FM}$ Max. Forward Voltage Drop (1)	0.41	0.475	V	@ 3A
	0.49	0.85	V	@ 9.4A
$I_{RM}$ Max. Reverse Leakage Current (1)	0.05	2.0	mA	$T_J = 25^\circ\text{C}$
	8.1	20	mA	$T_J = 100^\circ\text{C}$
$C_T$ Typical Junction Capacitance	350	-	pF	$V_R = 5V_{DC}$ (test signal range 100kHz to 1Mhz), @ $25^\circ\text{C}$
$L_S$ Typical Series Inductance	9.0	-	nH	Measured lead to lead 5mm from package body
dv/dt Max. Voltage Rate of Change	-	10000	V/ $\mu\text{s}$	(Rated $V_R$ )

(1) Pulse Width < 300 $\mu\text{s}$ , Duty Cycle < 2%

## Thermal-Mechanical Specifications

Parameters	1N5820	Units	Conditions
$T_J$ Max. Junction Temperature Range (2)	-65 to 150	$^\circ\text{C}$	
$T_{stg}$ Max. Storage Temperature Range	-65 to 150	$^\circ\text{C}$	
$R_{thJL}$ Max. Thermal Resistance Junction to Lead	34	$^\circ\text{C}/\text{W}$	With fin 20x20 (0.79x0.79) 1.0 thick
$R_{thJA}$ Max. Thermal Resistance Junction to Ambient	80	$^\circ\text{C}/\text{W}$	DC operation, without cooling fin
Wt Approximate Weight	1.2(0.042)	gr(oz)	
Case Style	C-16		

(2)  $\frac{dP_{tot}}{dT_J} < \frac{1}{R_{th(j-a)}}$  thermal runaway condition for a diode on its own heatsink

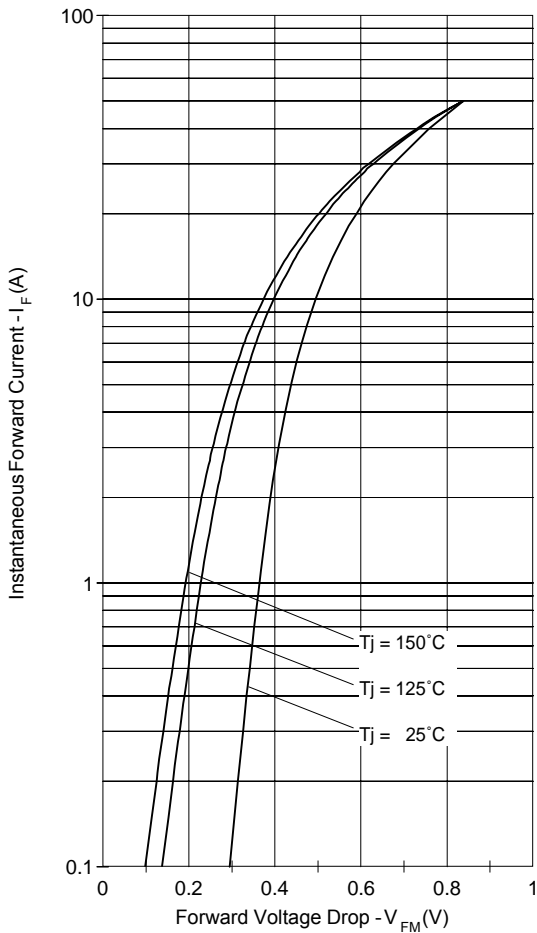

Fig. 1 - Typical Forward Voltage Drop Characteristics

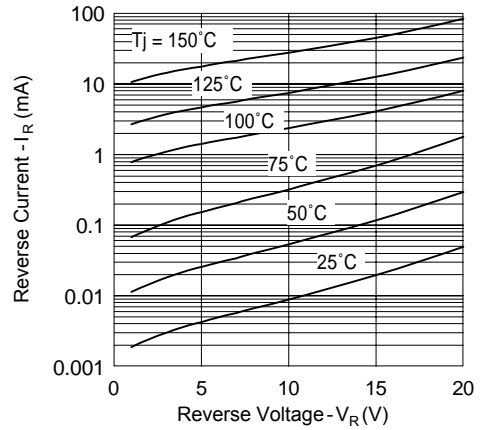

Fig. 2 - Typical Peak Reverse Current Vs. Reverse Voltage

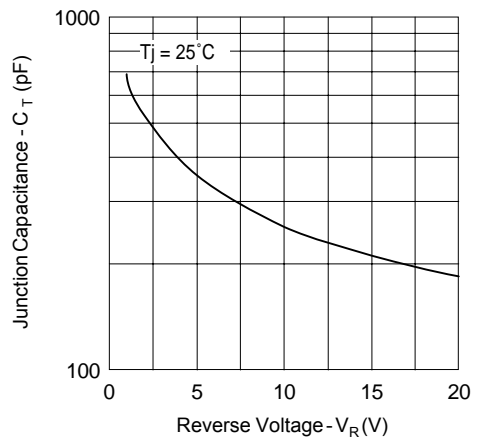

Fig. 3 - Typical Junction Capacitance Vs. Reverse Voltage

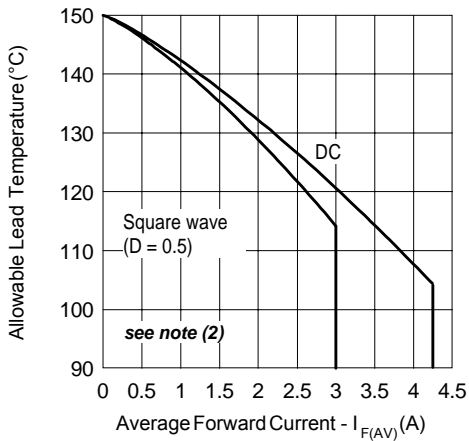

Fig. 4 - Maximum Average Forward Current Vs. Allowable Lead Temperature

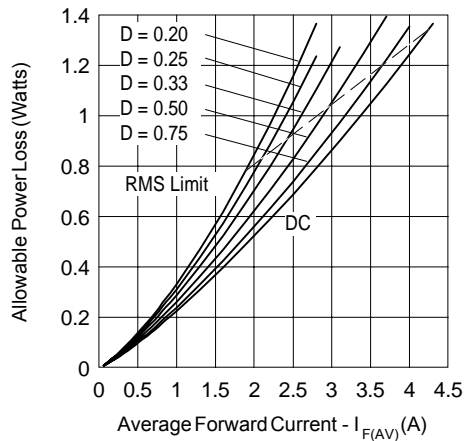

Fig. 5 - Maximum Average Forward Dissipation Vs. Average Forward Current

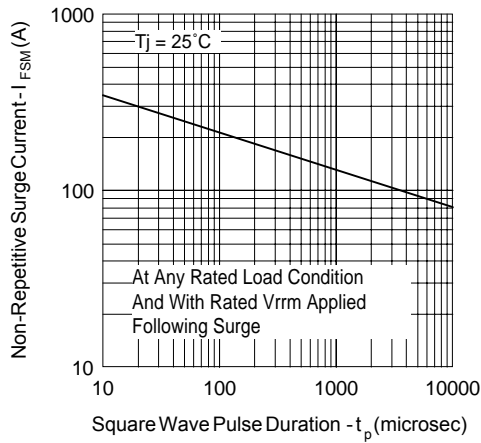

Fig. 6 - Maximum Peak Surge Forward Current Vs. Pulse Duration

- (2) Formula used:  $T_c = T_j - (Pd + Pd_{REV}) \times R_{thJC}$ ;  
 $Pd = \text{Forward Power Loss} = I_{F(AV)} \times V_{FM} @ (I_{F(AV)} / D)$  (see Fig. 6);  
 $Pd_{REV} = \text{Inverse Power Loss} = V_{R1} \times I_R (1 - D)$

### Ordering Information Table

<b>Device Code</b>	<b>1N5820</b>	<b>TR</b>
	①	②
<b>1</b>	-	Part Number: 3A, 20V
<b>2</b>	-	TR= Tape & Reel package (1200 pcs)
	-	= Box package (500 pcs)

Data and specifications subject to change without notice.  
This product has been designed for Industrial Level.  
Qualification Standards can be found on IR's Web site.

International  
**IR** Rectifier

**IR WORLD HEADQUARTERS:** 233 Kansas St., El Segundo, California 90245, USA Tel: (310) 252-7105  
TAC Fax: (310) 252-7309  
Visit us at [www.irf.com](http://www.irf.com) for sales contact information. 05/02